



LSS-100P

Installation and Operation Manual



181 Bonetti Dr. San Luis Obispo CA 93401 USA
Phone +1 805-549-0161, Fax +1 805-549-0163

Table of Contents

Table of Contents	2
Introduction	3
Features	4
Firmware Version	6
Installation	6
Installation.....	12
NTP, IR, and Luminance Check.....	13
Writing Command Scripts	13
Script Test Run.....	15
Data Analysis.....	15
CSV Data Use	16
Multiple Logs on One Page	17
Multiple Auditorium Summary.....	18
Ethernet Device Discoverer Windows version	18
Ethernet Device Discoverer iOS version	19
Ethernet Device TCP Based Operations	19
TCP_Send Command Usage	22
CP850 Control.....	22
Log Post XML Format	23
LSS-DB	24
Hidden Screens.....	24
View Configuration Data.....	24
Calibration Screens.....	24
Firmware Update	26
Restore Button	26
Useful Software.....	27
Ethernet Device Discoverer.....	27
LSS Database Software.....	28
Appendix A – Red/Green Flash Script Start	29
Appendix B – USB Power Interface and Contact Closure Script Start	30
Appendix C – Language Support.....	31
Product Support	32
Warranty.....	32
Manual Revision History	32

Introduction

The LSS-100P is designed for cinema auditorium quality control. It measures C-weighted sound pressure level (SPL) in dB, luminance in cd/m² and fL, chromaticity (x and y), and correlated color temperature. The LSS-100P makes all of these measurements available on a web interface, through TCP commands over Ethernet, and by posting data to a remote web server for further analysis and display.

In a typical installation, the digital cinema server runs a test show each day. The show consists of a composition containing red and green flashes that tell the LSS-100P to run one of its scripts. The script start composition is followed by a test composition. Several test compositions are available for different auditorium configurations. Each of these provide pink noise to each speaker in the auditorium. The LSS-100P measures the SPL from each speaker to detect changes in the system. The test compositions also include a white test pattern allowing the LSS-100P to measure peak luminance and chromaticity. These values are limit checked, logged, and optionally posted to a remote web server for further analysis.

The LSS-100P contains a color sensor, **not an image sensor**. There is no possibility of the LSS-100P transmitting an image of the movie, so it does not present any security issues.

The LSS-100P is powered by the supplied Power Over Ethernet power injector. If desired, it may also be powered using a USB cable.

The LSS-100P should be mounted on the rear wall of the auditorium. It is aimed towards the center of the screen using the internal LEDs. Before the first show or after the last show, a test pattern is projected and pink noise sent to each speaker. The LSS-100P measures the color, luminance, and SPL. These measurements are used to identify lamps nearing end of life, misadjusted lamps, projector color problems, defective speakers, etc.

Since measurements vary in different positions in the room, the measurements from the LSS-100P should be compared with previous measurements to detect changes rather than interpreting the absolute values delivered by the LSS-100P.

LSS-100P Package Contents	
1	LSS-100P Unit
1	POE Power Injector
1	Wall / Ceiling Mount (2 pieces)
1	LSS-100P User Manual

Features

- **Luminance Measurement** – Uses a precision detector with a photopic spectral response.
- **Chromaticity Measurement** – Uses a precision RGB sensor and calculates XYZ, xy, and CCT.
- **SPL Measurement** – Uses a DSP generated C-weighting filter and RMS detector for accurate results regardless of signal waveform or crest factor.
- **IR Measurement** – Measures relative IR illumination of screen to detect issues with IR emitters used for hearing impaired audio, visually impaired audio, or closed captions.
- **Temperature Measurement** – Includes an internal temperature sensor that can be used to approximate auditorium temperature and track changes.
- **Web Interface** – Displays live measured data along with user defined reference values. The web interface supports language translation tables based on the language requested by the browser. Currently the web interface supports English (en) and Chinese (zh).
- **Automatic Start Clips** – Three Red/Green start clips packaged as DCPs that can automatically trigger user scripts in the LSS-100P.
- **TCP Command Interpreter** – Accepts commands over Ethernet to log data, send current measurement, start a measurement script, etc.
- **Command Scripting** – An unlimited number of user scripts (up to a total of 65,530 characters) may be defined. Scripting permits a sequence of measurements to be made automatically.
- **Script Triggering** – Scripts are typically triggered using a red/green flash sequence at the start of the test show. As an alternative, scripts may be started with a command over TCP or by a contact closure. See appendix ??? for information on alternate script start mechanisms.
- **Logging with Limit Checking and Graph Generation** – The LSS-100P can capture measurements to a log. The log shows the measurement in red if it is outside user defined limits. The log can be downloaded as a CSV file for analysis in a spreadsheet. The LSS-100P generates graphs of logged data showing trends of the measured data along with limit lines.
- **Web Services Posting** – The LSS-100P can post log data to one or more HTTP or HTTPS servers. Log data is sent as XML for simple parsing into a database for report generation. The USL provided [LSS-DB](#) can run on a user-provided server to gather information from a large number of LSS-100P devices and generate reports and alerts.
- **Power Over Ethernet** – The LSS-100P is powered by a POE enabled Ethernet switch or the supplied power injector. Use of POE simplifies installation since fewer wires need to be run. The LSS-100P is an IEEE 802.3af class 1 powered device. It may be powered by “active” (power sources that use the POE signature) or “passive” (power sources that do not use the standard POE signature) 48V POE injectors. The LSS-100P consumes less than 1.5W.
- **USB Power** – As an alternative, the LSS-100P can be powered by a USB power supply.

USL, inc.
Precision Sound • Light • Color

Bonetti Triplex - Screen 1

LIVE 2D Scope

Luminance	17.8fL	28.4fL
x	0.391	0.404
y	0.444	0.460
CCT	4139K	3962K
Temperature	29.0° C	29.3° C

LIVE

SPL	59.9dBc
-----	---------

Auditorium Info

Theater Name	Bonetti Triplex
Theater Number	1
Screen Number	1
Comments	

[Log](#) | [Config](#)

Figure 1- LSS-100P Home Page

USL, inc.
Precision Sound • Light • Color

Bonetti Triplex - Screen 1

Record Number	UTC Time	GUI Time Pacific Standard Time	LSS Time PDT	Description	Measured Value
2057	Mon Jun 2 05:31:34 2014	Sun Jun 1 22:31:34 2014	Sun Jun 1 22:31:34 2014	SPL Left Low	82.8dBc
2058	Mon Jun 2 05:32:04 2014	Sun Jun 1 22:32:04 2014	Sun Jun 1 22:32:04 2014	SPL Left Mid	80.1dBc
2059	Mon Jun 2 05:32:34 2014	Sun Jun 1 22:32:34 2014	Sun Jun 1 22:32:34 2014	SPL Left High	78.9dBc
2060	Mon Jun 2 05:33:04 2014	Sun Jun 1 22:33:04 2014	Sun Jun 1 22:33:04 2014	SPL Right Low	83.4dBc
2061	Mon Jun 2 05:33:34 2014	Sun Jun 1 22:33:34 2014	Sun Jun 1 22:33:34 2014	SPL Right Mid	79.5dBc
2062	Mon Jun 2 05:34:04 2014	Sun Jun 1 22:34:04 2014	Sun Jun 1 22:34:04 2014	SPL Right High	77.9dBc
2063	Mon Jun 2 05:34:34 2014	Sun Jun 1 22:34:34 2014	Sun Jun 1 22:34:34 2014	SPL Center Low	79.4dBc
2064	Mon Jun 2 05:35:04 2014	Sun Jun 1 22:35:04 2014	Sun Jun 1 22:35:04 2014	SPL Center Mid	79.5dBc
2065	Mon Jun 2 05:35:34 2014	Sun Jun 1 22:35:34 2014	Sun Jun 1 22:35:34 2014	SPL Center High	81dBc
2066	Mon Jun 2 05:36:04 2014	Sun Jun 1 22:36:04 2014	Sun Jun 1 22:36:04 2014	SPL LFE	83.1dBc
2067	Mon Jun 2 05:36:34 2014	Sun Jun 1 22:36:34 2014	Sun Jun 1 22:36:34 2014	SPL Ls	87.3dBc
2068	Mon Jun 2 05:37:04 2014	Sun Jun 1 22:37:04 2014	Sun Jun 1 22:37:04 2014	SPL Rs	85.4dBc
2069	Mon Jun 2 05:37:34 2014	Sun Jun 1 22:37:34 2014	Sun Jun 1 22:37:34 2014	SPL Lrs	88.9dBc
2070	Mon Jun 2 05:38:04 2014	Sun Jun 1 22:38:04 2014	Sun Jun 1 22:38:04 2014	SPL Rrs	88.5dBc
2071	Mon Jun 2 05:38:04 2014	Sun Jun 1 22:38:04 2014	Sun Jun 1 22:38:04 2014	Luminance	61.5fL
2072	Mon Jun 2 05:38:04 2014	Sun Jun 1 22:38:04 2014	Sun Jun 1 22:38:04 2014	Color x	0.317x
2073	Mon Jun 2 05:38:04 2014	Sun Jun 1 22:38:04 2014	Sun Jun 1 22:38:04 2014	Color y	0.344y
2074	Mon Jun 2 05:38:04 2014	Sun Jun 1 22:38:04 2014	Sun Jun 1 22:38:04 2014	IR Level	0%
2075	Mon Jun 2 05:38:06 2014	Sun Jun 1 22:38:06 2014	Sun Jun 1 22:38:06 2014	Posted to http://iss.uslinc.com/xml/post.php	3.26e+03
2076	Mon Jun 2 07:09:39 2014	Mon Jun 2 00:09:39 2014	Mon Jun 2 00:09:39 2014	Max SPL of day	99.6dBc

[Status Page](#) | [First Log Page](#) | [Previous Log Page](#) | [Next Log Page](#) | [Last Log Page](#) | [CSV](#)

Figure 2 - LSS-100P Log

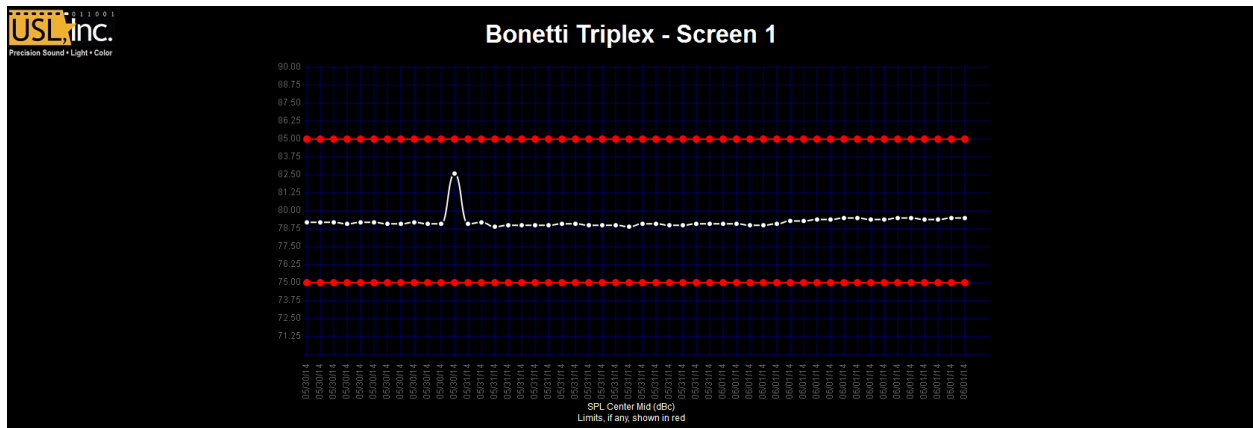

Figure 3 - LSS-100P Graph

Firmware Version

The LSS-100P is subject to constant improvement. Check <http://ftp.uslinc.com/LSS-100P> for the latest firmware. Note that the latest firmware can be used in both the LSS-100 and the LSS-100P. The LSS-100 does not have POE, the separate photopic sensor, contact closure script start, or the IR sensor. Otherwise, the units will behave the same with the latest firmware. See the Firmware Update section for instructions on updating the firmware.

Installation

It is a lot easier to do the initial testing of the LSS-100P on a table or the floor of the projection booth instead of on top of a ladder.

1. Connect an Ethernet cable between the OUT connector of the supplied POE Power Injector and the LSS-100P. Connect another Ethernet cable from the IN connector of the POE Power Injector to a computer. Apply AC power to the POE Power Injector.
2. The green LED next to the Ethernet connector on the LSS-100P will light dimly for 30 seconds, then light brightly. During this time, the LSS-100P is checking its backup copy of the system firmware. The green LED is lit whenever the LSS-100P is powered unless the flash memory chip is being accessed (such as during the firmware check, loading or saving of configuration information, etc.).
3. Open a web browser and type <http://169.254.1.6> in the address bar. On most laptops, this will bring up the home page of the LSS-100P. If it does not, try changing the laptop's IP address to 169.254.1.123 with a subnet mask of 255.255.0.0. Most laptops have automatic crossover for Ethernet, but some older ones do not. If the LSS-100P home page is still not visible, try using an Ethernet crossover cable between the laptop and the POE injector. The LSS-100P home page is shown below.

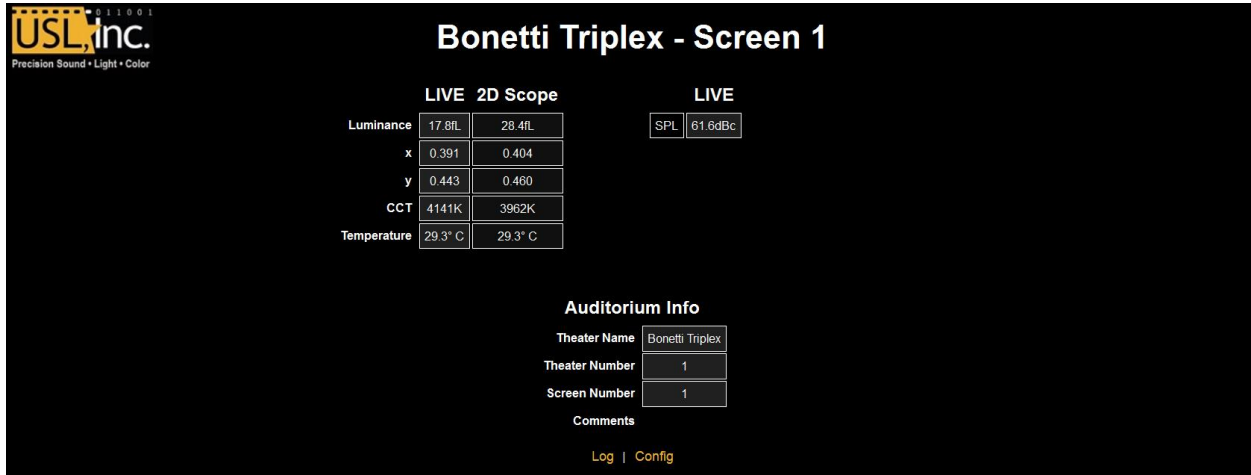

Figure 4 - LSS-100P Home Page

- Click on the “config” to go to the Configuration Page. The username is “admin” and the password is “ultra”. There are several configuration pages that are described below.

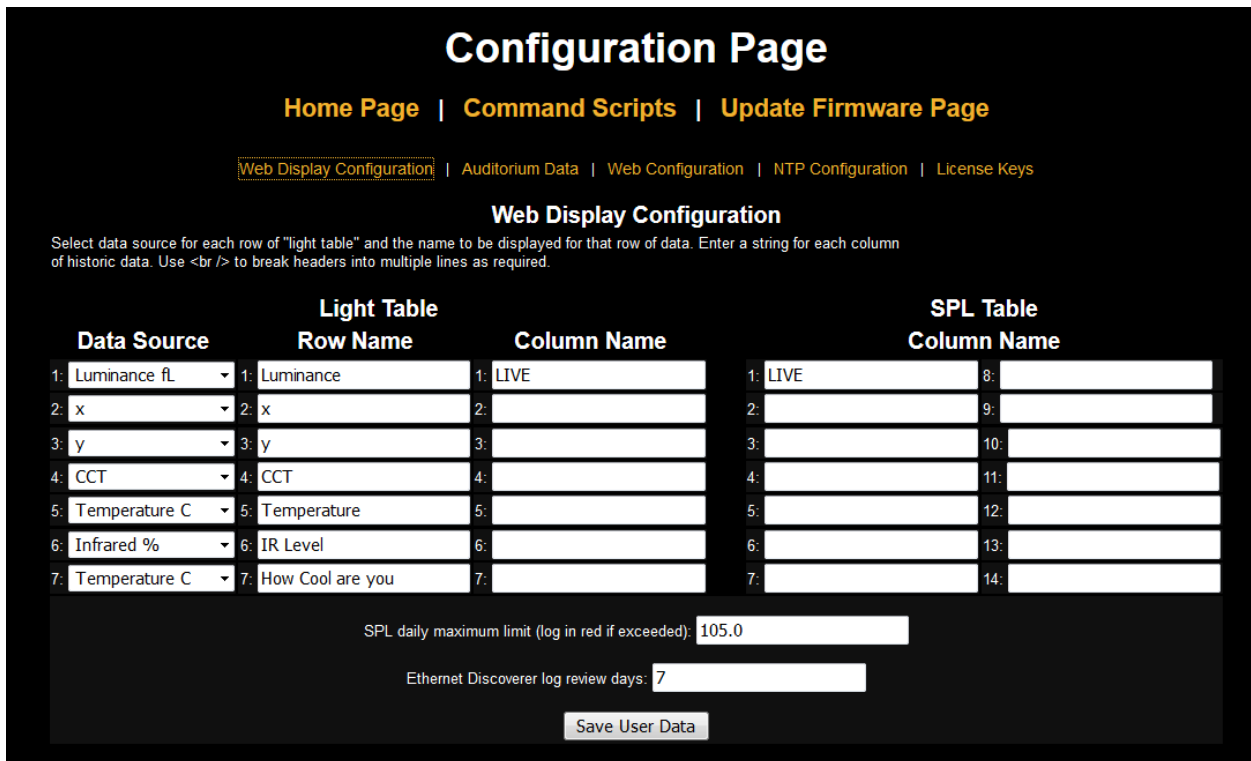

Figure 5 - LSS-100P Web Display Configuration Page.

- The first configuration page, shown above, allows you to determine how the home page will appear. The Light Table section determines how the left side of the home page will appear (the side that is showing luminance, color, etc.). The home page can show up to 7 rows of light information. The source of that information is set by the first column of the light table. You can select U.S. or metric units for temperature and luminance. LSS-100P units with board revision F or higher also measure the relative IR illumination of the screen. This is useful for detecting

issues with IR audio and captioning systems. Select the data source for each line of the home page light display.

6. Set the name for each line of the home page light display. These may be in any language.
7. The light table of the home page supports a total of 7 data columns. The first column is always the current “live” measurement data. Additional columns hold reference measurements. Live data is copied to the reference measurement column by clicking on the header of the column on the home page. Define a name for each of the data columns, The first column is always labeled LIVE.
8. The right side of this configuration screen allows reference column names to be defined for the SPL measurement. These behave the same as the light reference measurements described in the previous step. Up to 14 SPL reference columns may be defined.
9. The LSS-100P determines the highest SPL it measured from midnight local time to midnight local time. The highest value is logged each night at midnight. You can set a limit for the maximum SPL on this page. If this value is exceeded, the maximum SPL of the day will be shown in red on the log.
10. The LSS-100P makes out of tolerance readings available to the USL Ethernet Device Discoverer (see <http://ftp.uslinc.com/?dir=ftp/Products/EthernetDeviceDiscoverer>). Ethernet Device Discoverer “discovers” USL products on the network. In addition, it shows status messages from each device. If Ethernet Discoverer Log Review Days is set to 7 (as shown in figure 7), Ethernet Device Discoverer will display any out of tolerance readings logged in the past 7 days.
11. Once this data has been entered, click the “Save User Data” button to save the settings to the LSS-100P.
12. Click the “Auditorium Data” link at the top of the page.

Configuration Page

[Home Page](#) | [Command Scripts](#) | [Update Firmware Page](#)

[Web Display Configuration](#) | [Auditorium Data](#) | [Web Configuration](#) | [NTP Configuration](#) | [License Keys](#)

Auditorium Data

Organization Key:

Theater Name:

Theater Number:

Screen Number:

Distance LSS-100P to Screen (ft):

Comments:

Luminance Scaling

Scale luminance reading as required to compensate for LSS placement and screen gain.
Enter desired luminance in appropriate box to set scaling.
Press Reset Luminance Scaling to return luminance to original calibration.

fL cd/m²

IR Calibrate

Press button to set current IR level as 100% reference.

Figure 6 - LSS-100P Auditorium Data

13. Enter the theater name, theater number (large groups often identify a particular theater by number), and the screen or auditorium number. Note that the theater number and screen number *must* be numbers (not names). The “Organization Key” is used by the LSS Database software to identify multiple theaters as part of company or organization. A particular LSS-100P can be uniquely identified by the OrgKey, Theater Number, and Screen Number. The “Distance of LSS-100P to Screen” field is used when running the audio/video sync check (coming soon). Additional information about the auditorium can be entered in the Comments field. These comments show up on the home page and are reported in the XML web services log data. Click the “Save Auditorium Data” button to save the data. Ignore the luminance scaling and IR Calibrate sections for now.
14. Click the Web Configuration link at the top of the page.

Configuration Page

[Home Page](#) | [Command Scripts](#) | [Update Firmware Page](#)

[Web Display Configuration](#) | [Auditorium Data](#) | [Web Configuration](#) | [NTP Configuration](#) | [License Keys](#)

Network Configuration

MAC Address: 00:23:FC:06:15:4F

Host Name:

IP Address:

Gateway:

Subnet Mask:

Primary DNS:

Secondary DNS:

After hitting Save, you will need to put the new IP address in your browser if you changed the IP address.

Figure 7 - LSS-100P Web Configuration

15. Enter the host name (NET BIOS host name), IP address, gateway, subnet mask, and DNS information. DNS is used if the NTP server or web services server (log posting in command scripts, CP850 test, etc.) is specified by a host name instead of an IP address. If IP addresses are used instead of host names, these fields can be left at 0.0.0.0. The default 8.8.8.8 is a DNS service provided by Google. After the network information has been entered, click the "Save Config" button to save the settings. Note that the new IP address takes effect immediately, so it will be necessary to address the LSS-100P at its new address and will probably be necessary to change the laptop computer's IP address to an address on the same subnet.
16. Click the NTP Configuration link at the top of the page.

Configuration Page

[Home Page](#) | [Command Scripts](#) | [Update Firmware Page](#)

[Web Display Configuration](#) | [Auditorium Data](#) | [Web Configuration](#) | [NTP Configuration](#) | [License Keys](#)

NTP Configuration

NTP IP Address:

Time Zone Offset from UTC (hours):

Standard Time Abbreviation:

DST (Summer Time) Abbreviation:

DST (Summer Time) Observed:

NTP Last Updated: Tue Mar 15 04:10:55 2016 PDT

Figure 8 - LSS-100P NTP Configuration

17. An NTP server is required for the LSS-100P logging. Most digital cinema servers have an NTP server in them, so the IP address of that server can be entered. If outgoing internet access is available, the default setting of pool.ntp.org can be used. The NTP server IP address can be entered as a dotted decimal IP address. If a DNS server was set up on the Web Configuration screen, a domain name (such as pool.ntp.org) can be used instead.
18. Set the time zone UTC offset. Offsets for U.S. time zones are shown in figure 11. Note that fractions of an hour can be set (required for Venezuela, Afghanistan, India, Sri Lanka, Nepal, and other countries). Note that this is the offset for standard time, not advanced time, summer time, or daylight saving time. Additional time zone information is available at <http://www.timeanddate.com/library/abbreviations/timezones/> and http://en.wikipedia.org/wiki/List_of_time_zones_by_UTC_offset.

US Time Zone	UTC Offset	Standard Time Abbreviation	Daylight Saving Time Abbreviation
Hawaii-Aleutian	-10.0	HAST	HADT
Alaska	-9.0	AKST	AKDT
Pacific	-8.0	PST	PDT
Mountain	-7.0	MST	MDT
Central	-6.0	CST	CDT
Eastern	-5.0	EST	EDT

Figure 9 - U.S. Time Zone Offsets

19. Enter the abbreviations for standard and advanced, summer, or daylight saving time. Select whether daylight saving (or similar) is observed at the location the LSS-100P is installed. This setting is not whether DST is *currently* being observed, but whether it is *ever* observed. For example, in the U.S., this would be set to “no” for Arizona and “yes” for California. The LSS-100P displayed logs will take this into consideration when displaying the time at the LSS-100P.
20. Note that the bottom line of this page shows the last time the LSS-100P clock was updated from the NTP server. Since the LSS-100P does not have access to an NTP server when it is only connected to your laptop, this will indicate that the last update was never.
21. Click the License Keys link at the top of the page. License keys are required to enable certain advanced features in the LSS-100P. Contact USL to obtain a key for a particular LSS-100P (the serial number of the LSS-100P will be required to issue the key. When a valid key is entered, the key turns green. An invalid key shows up in red. At this time, the only license key available enables control of the Dolby CP850 (enabling and disabling a test mode).

Configuration Page

Home Page | Command Scripts | Update Firmware Page

Web Display Configuration | Auditorium Data | Web Configuration | NTP Configuration | **License Keys**

License Keys

Feature	License Key
A green license key indicates the key is valid and the feature is enabled.	
CP850 Control	20fe27a23cd118fa5f1a8b4f928dbb64
AV Sync Check	

Figure 10 - License Key Configuration Page.

Installation

1. Use the supplied OmniMount 10.0 wall mount to attach the LSS-100P to the auditorium back wall. Aim the lens and microphone towards the screen. Thread the supplied nut onto the OmniMount threaded rod with the flat side of the nut towards the threaded end and away from the ball. Thread the OmniMount threaded rod into the threaded hole on the LSS-100P turning the LSS-100P four turns, adjusting a fraction of a turn as required to point the LSS-100P towards the screen. Tighten the nut on the threaded rod against the LSS-100P case to firmly mount the LSS-100P to the threaded rod.
2. If necessary, drill a hole between the booth and auditorium for the wiring. Since the LSS-100P uses Power Over Ethernet, only an Ethernet cable needs to be run. See Appendix ??? if USB power or contact closure script start is desired.
3. Connect the Ethernet cable to the LSS-100P the supplied POE power injector OUT port. Connect another cable from the POE injector IN port to the auditorium Ethernet switch. If the auditorium has a POE enabled Ethernet switch, the Ethernet cable from the LSS-100P can be plugged directly into the switch.
4. Turn the LSS-100P LED switch to on and adjust the focus control until the red spots on the screen appear to be in focus. As the LSS-100P is adjusted out of focus, the hole in the middle of the spots fills in. When the LSS-100P is in focus, the hole in the center will be open and the edges sharp as shown in Figure 12. Once focus is set, lock the lens position by tightening the thumb screw on the lens tube.
5. Project the test pattern on the screen. Suggested test content is the USL LST-100 DCP. It is available from USL on a USB flash drive or can be downloaded from <http://ftp.uslinc.com/?dir=ftp/Products/LSS-100P/Software/TestContent> . Position the LED spots to be in the center of the test pattern area. Since the projector lamp is much more powerful than the LEDs in the LSS-100P, it may be difficult to see the LED spots when the test pattern is on. A simple method of seeing where the LED spots are within the test pattern is to wave a hand through the projector beam, casting a shadow on the screen. As the shadow moves across the screen, the LED spots and their location within the test pattern will become visible. The LSS-100P sensor is a linear sensor positioned midway between the LEDs. If the test pattern is tall, adjust the LSS-100P to align the spots vertically. If the test pattern is wide, rotate the LSS-100P to align the spots horizontally. Place the center of the area between the spots in the center of the test pattern area. Lock the Omnimount position and turn off the LEDs.



Figure 12 - LSS-100 LED Focus and aim.

6. Turn on a pink noise source on one of the auditorium speakers (or play the test DCP which contains pink noise on each speaker in sequence). The SPL indicated by the LSS-100P should be close to that measured with an SPL meter. Again, due to system tolerances and variations in sound level throughout the auditorium, the numbers will not match precisely.

NTP, IR, and Luminance Check

1. Go back to the NTP configuration page (shown in figure 8) and ensure that the LSS-100P has received an NTP update.
2. If desired, the LSS-100P luminance measurement can be scaled to agree with a reference meter. The LSS-100P is factory calibrated, but, because it is not in the same location as a reference meter in the auditorium, it will probably read slightly different from the reference meter due to screen gain, elevation of the projector above the screen center, etc. Project the test pattern (ideally from the LST-100) and measure the luminance with the reference meter. While the test pattern is still present, key the measured luminance value into the appropriate box (cd/m² or fL) in the Luminance Scaling section of the Auditorium Data page (see figure 6). Click the “Save Settings” button to scale the LSS-100P luminance measurement to match the reference meter. You can click the “Reset Luminance Scaling” button to return the LSS-100P to factory calibration.
3. IR Calibrate also appears on the Auditorium Data page (board revision F and higher). Press the “Set IR Reference” button when typical IR illumination of the screen is present. When the LST-100 test content plays, a USL UPC-28C emitter transmits the hearing impaired and closed caption carriers, but not the visually impaired carrier. If you click the “Set IR Reference” button when the LST-100 content is playing, the LSS-100P will set this level to 100%. The LSS-100P will read about 75% if only one IR carrier is present. It will read about 117% if all 3 carriers are present.

Writing Command Scripts

The LSS-100P script definition page includes default scripts. These can be copy and pasted into the script definition window. This section covers running the test DCP and configuring limits on the scripts.

1. Download the LSS-100P test content from <http://ftp.uslinc.com/?dir=ftp/Products/LSS-100P/Software/TestContent> . The README.txt file describes the test content and provides sample scripts.
2. There are three ways that a Command Script may be triggered. The recommended method is to use the red/green script trigger clips located that is included in the content downloaded in step 1. Create a show playlist with an LST-START clip followed by the desired test content (such 5.1 3-band). Note that we have found that the red/green script trigger clips may not work with some laser projectors. If this is the case with your projector, use one of the other methods of starting a script as defined in Appendix ????.
3. Add appropriate cues to the playlist to set the sound processor at reference level (0.0dB or 7.0) and take audio from the digital cinema server, turn on the projector lamp, open the dower, turn off the house lights, etc.
4. Click the “Command Scripts” link at the top of the configuration page. A page similar to Figure 11 should appear. Lines starting with # are comments and are ignored. Blank lines separate scripts. The first script is script 0. LST-Start-A is the red/green clip that starts script 0. LST-Start-B starts script 1, etc. There’s a blank line at the end of script 0. The next line is the start of script 1. Only insert one (not more) blank lines between scripts. There should be nothing on the blank

lines between scripts (not even space characters). Fields are delimited with the pipe character (|). The various capture commands have these fields:

- a) The command ("lss100.sys.capture_spl").
 - b) A user defined description of what is being measured ("Left Low").
 - c) A minimum limit ("75").
 - d) A maximum limit ("85").
5. Use the appropriate sample script from the README.txt file or the default script window on the LSS-100P Script Definition page.
 6. Run the test show (the red/green flashes should start the LSS script). When it is complete, verify that data has been saved in the log. Print the log for reference in the next few steps.
 7. Based on the test run of the show, adjust the minimum and maximum values for each measurement. The measured SPL values will vary as different bands and different speakers are run. We suggest setting limits 3dB below and above the values measured on the test show. Failures in the audio equipment will result in values outside this range. Note that the limits set for luminance and chromaticity are based on SMPTE standards and should not require adjustment. Note that the description portion of each line of the script is user definable. Descriptions in other languages may be substituted, if desired. These descriptions will be used in the LSS-100P internal log, graphing, and web services (LSS-DB) reporting. If there are no limits on a measurement, leave the minimum and maximum out (end the line after the description). Internally and in web services reporting, a log record with no limits has its minimum set to -9e9 and its maximum set to +9e9.
 8. If web services LSS-DB reporting is desired, put the URL of the server in the lss100.sys.log_post line. For example, "lss100.sys.log_post|http://lss.uslinc.com/post.php" posts the log to the USL LSS server. The URL can be either HTTP or HTTPS. A port number, username, and password may be included in the post URL. For example, <http://user:pw@example.com:1234/path/filename>. If posting to more than one server, include a wait between log posts to ensure the first log post is complete before the second is attempted. The LSS-100P can only post to one server at a time. A suggested wait command is "lss100.sys.script_wait|120". The LSS-100P logs a hash of the URL on a successful log post. When another log post is executed, the LSS-100P searches back through the log for another log post with the matching URL. Log records from that point on are posted to the server. Each server receives all logs even if a post fails (they are picked up on the next post).

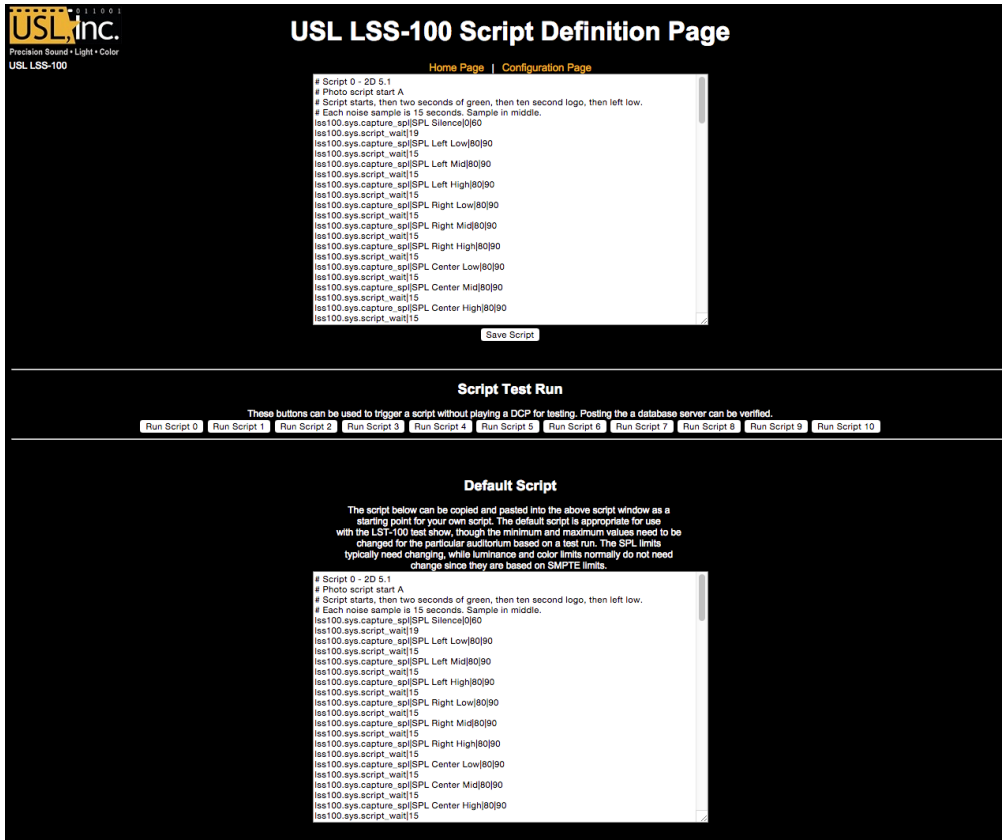

Figure 11 - LSS-100P Command Script Page

9. Click the “Save Script” button to save the revised script.
10. Run the test show a couple times and review the log. It should appear similar to figure 2 but with the latest values not in red. Measured values that are not between the specified minimum and maximum are shown in red.
11. Click on a value in the log. A graph of the measured values (similar to figure 3 but with fewer values) should appear. If the test script has only run once, no graph will appear. At least two measurements are required to draw the graph.

Script Test Run

The script test run buttons located on the Command Script Definition page allow the user to manually trigger LSS-100P Command Scripts without having to run the corresponding DCP show normally used. This may be useful when testing the “post to server” commands.

Data Analysis

The LSS-100P presents the captured data in a log (as shown in figure 2) and a graph (as shown in figure 3). Out of limit operation is easily identified in the log by a value being printed in red. The graphs show the measured values along with limit lines allowing easy detection of trends and out of limit operation. Ethernet Device Discoverer (<http://ftp.uslinc.com/?dir=ftp/Products/EthernetDeviceDiscoverer>) can also be used to show out of tolerance operation within a theater.

Log data is also available as a Comma Separated Value file for analysis in a spreadsheet. Click the CSV link at the bottom of a log page to get the CSV log.

Log data can also be posted to a web server as XML for further analysis and consolidation with data from other sites.

CSV Data Use

Click CSV to download the log as a comma separated value file for importing the data into a spreadsheet. A portion of a typical download is shown below.

Record Number	Time Stamp	LSS Time (PDT)	Excel Format	Description	Value	Units	min	max
0	1401461114		41789.32308	Silence	54.3	dBc	50	60
1	1401461144		41789.32343	SPL Left Low	87.1	dBc	82.7	88.7
2	1401461175		41789.32379	SPL Left Mid	73.9	dBc	70.5	76.5
3	1401461205		41789.32413	SPL Left High	76.4	dBc	73.9	79.9
4	1401461235		41789.32448	SPL Right Low	85.5	dBc	80.7	86.7
5	1401461265		41789.32483	SPL Right Mid	77.5	dBc	74.1	80.1
6	1401461295		41789.32517	SPL Right High	79.9	dBc	76.7	82.7
7	1401461325		41789.32552	SPL Center Low	81.1	dBc	77.4	83.4
8	1401461355		41789.32587	SPL Center Mid	73	dBc	70.8	76.8
9	1401461385		41789.32622	SPL Center High	75.1	dBc	73.9	79.9
10	1401461415		41789.32656	SPL LFE	85.1	dBc	80.8	86.8
11	1401461446		41789.32692	SPL Ls	83.4	dBc	80.9	86.9
12	1401461476		41789.32727	SPL Rs	84.7	dBc	81.3	87.3
13	1401461476		41789.32727	Luminance	9.21	fL	11	17
14	1401461476		41789.32727	Color x	0.312	x	0.308	0.32
15	1401461476		41789.32727	Color y	0.35	y	0.345	0.357
16	1401461476		41789.32727	IR Level	99.2	%	90	150
17	1401461479		41789.3273	Posted to http://lss.uslinc.com/xml/post.php	3.26E+03		-9.00E+09	9.00E+09

Figure 12 - LSS-100P CSV Data

Change the format of column C (LSS Time) to date. The result is shown below:

Record Number	Time Stamp	LSS Time (PDT)	Excel Format	Description	Value	Units	min	max
0	1401461114		5/30/2014	Silence	54.3	dBc	50	60
1	1401461144		5/30/2014	SPL Left Low	87.1	dBc	82.7	88.7
2	1401461175		5/30/2014	SPL Left Mid	73.9	dBc	70.5	76.5
3	1401461205		5/30/2014	SPL Left High	76.4	dBc	73.9	79.9
4	1401461235		5/30/2014	SPL Right Low	85.5	dBc	80.7	86.7
5	1401461265		5/30/2014	SPL Right Mid	77.5	dBc	74.1	80.1
6	1401461295		5/30/2014	SPL Right High	79.9	dBc	76.7	82.7
7	1401461325		5/30/2014	SPL Center Low	81.1	dBc	77.4	83.4
8	1401461355		5/30/2014	SPL Center Mid	73	dBc	70.8	76.8
9	1401461385		5/30/2014	SPL Center High	75.1	dBc	73.9	79.9
10	1401461415		5/30/2014	SPL LFE	85.1	dBc	80.8	86.8
11	1401461446		5/30/2014	SPL Ls	83.4	dBc	80.9	86.9
12	1401461476		5/30/2014	SPL Rs	84.7	dBc	81.3	87.3
13	1401461476		5/30/2014	Luminance	9.21	fL	11	17
14	1401461476		5/30/2014	Color x	0.312	x	0.308	0.32
15	1401461476		5/30/2014	Color y	0.35	y	0.345	0.357
16	1401461476		5/30/2014	IR Level	99.2	%	90	150
17	1401461479		5/30/2014	Posted to http://lss.uslinc.com/xml/post.php	3.26E+03		-9.00E+09	9.00E+09

Figure 13 - LSS-100P CSV with Local Time Converted

Sort the spreadsheet on column D (description) to gather like readings together. Graphing or analysis can then be easily accomplished. The image below shows the generation of a plot of the SPL from the center channel mid-band measurements.

LSS-100P Installation & Operation Manual

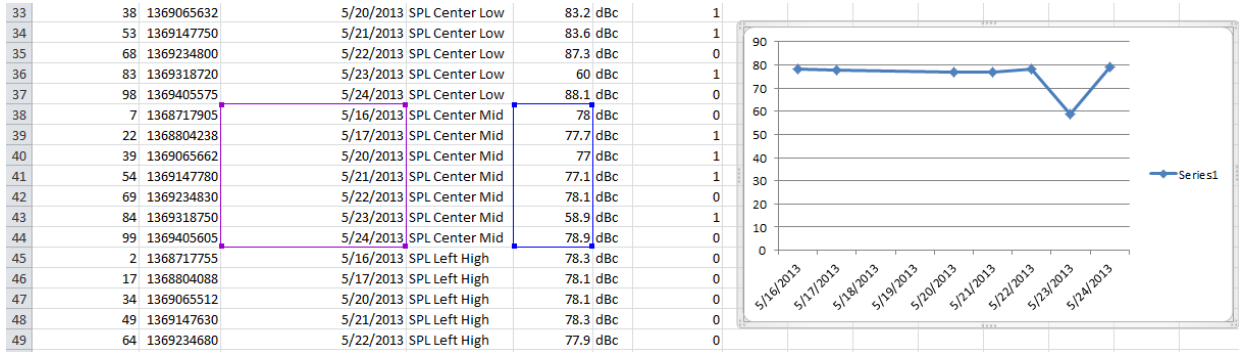

Figure 14 – Graph Generation from LSS-100P CSV Data

Multiple Logs on One Page

It may be desirable to have a single web page that includes the logs from multiple LSS-100P units (for example, all the auditoriums in a particular theater). This can be accomplished using HTML iframes (inline frames). Sample code to include multiple LSS-100P log pages is shown below. This code can be placed on the computer the browser is running on or on a local web server.

```
<!doctype html>
<html>
  <head>
    <title>Obispo LSS-100 Summary</title>
  </head>
  <body>
    <h1 align="center">Obispo LSS-100 Summary</title>
    <iframe seamless frameborder="0" src="http://192.168.6.55/log.cgi?n=20&GuiTz=-25200&GuiTzName=Pacific%20Standard%20Time&DST=1" width="100%" height="700"></iframe><br />
    <iframe seamless frameborder="0" src="http://192.168.6.110/log.cgi?n=20&GuiTz=-25200&GuiTzName=Pacific%20Standard%20Time&DST=1" width="100%" height="700"></iframe>
  </body>
</html>
```

The iframe does a “client side include” of multiple web pages. The attributes of the iframe tag are described below.

The seamless and frameborder=“0” attributes merge the fetched log pages into the resulting page with no frame borders so it appears to be one page.

The src attribute contains the URL of the log to be inserted at this point. It is simplest to connect to the LSS-100P home page, click log, then copy the resulting URL for use here with the changes listed below.

Delete the “rn=xx&” from the URL. rn holds the first record number to be displayed. The next part of the URL (“n=100”) indicates how many records will be shown. If rn is deleted, the LSS-100P shows the n most recent records. By deleting rn from the URL in the iframe, your page will always show the most recent log entries.

Change “n=100” to “n=20” or some other number indicating the number of log entries you want shown on this combined log page. If you do a daily log review, you may want to show three days worth of log entries to ensure data from weekends is reviewed.

GuiTz can generally remain unchanged. It is the offset in seconds from UTC where the browser is located. Similarly, the GuiTzName can remain unchanged. You may need to change DST between 1 and 0 depending on whether daylight saving time is currently in effect. You could build two pages (one for DST and one for standard time) or include the javascript at the top of the LSS-100P home page that determines whether DST is in effect at the GUI.

The width attribute is set to 100% so the iframe consumes 100% of the width of the browser window. The height is specified in pixels. If this is too small, scroll bars will appear on the resulting web page for each of the iframes. Making it too large results in empty space on the page. Experiment with this until you get the look you want for multiple logs on a single web page.

Multiple Auditorium Summary

Another method of presenting multiple auditoriums on a single web page is to build a list of links to the auditoriums. The LSS-100P automatically supplies a link to a log that includes the theater name and the screen number. If there is an out of limits log entry in the log record range specified, the log link appears in red. You don't have to look at logs from auditoriums where all is well. Sample HTML is shown below.

```
<!doctype html>
<html>
  <head>
    <title>Obispo LSS-100 Summary</title>
  </head>
  <body>
    <h1 align="center">Obispo LSS-100 Summary</title>
    <iframe seamless frameborder="0" src="http://192.168.6.55/loglink.cgi?n=20&GuiTz=-
25200&GuiTzName=Pacific%20Standard%20Time&DST=1" width="100%" height="50"></iframe><br
/>

    <iframe seamless frameborder="0" src="http://192.168.6.110/loglink.cgi?n=20&GuiTz=-
25200&GuiTzName=Pacific%20Standard%20Time&DST=1" width="100%" height="50"></iframe>
```

Most of the iframe attributes are similar to the previous example. As noted before, the lack of an `rn` in the `src` attribute tells the LSS-100P to evaluate the last `n` records for an out of limit condition. In the examples above, a particular log link will be red if one of the last 20 records shows an out of limits condition.

The image below shows how the HTML above appears in our test system:

[USL San Luis Obispo - Screen 1](#)

[USL San Luis Obispo - Screen 4](#)

Figure 15 - LSS-100P Multiple Auditorium Links

Ethernet Device Discoverer Windows version

Ethernet Device Discoverer (<http://ftp.uslinc.com/?dir=ftp/Products/EthernetDeviceDiscoverer>) discovers USL devices on a network. In addition, it shows the status of discovered LSS-100P

lss100.sys.auditorium	1	Returns the auditorium number entered on the configuration page.
lss100.sys.cct	6255.250284	Returns the correlated color temperature.
lss100.sys.cdm2	405.151492	Returns the luminance in candelas per square meter
lss100.sys.comments	Conference Room	Returns the auditorium comments entered on the configuration page.
lss100.sys.ftl	118.332596	Returns the measured luminance in foot-Lamberts
lss100.sys.spl	83.239520	Returns the measured sound pressure level in dBc
lss100.sys.temperature	29.2\t84.	Returns the internal temperature in degrees C and degrees F (separated by tab).
lss100.sys.theater_name	USL San Luis Obispo	Returns the theater name entered on the configuration page.
lss100.sys.theater_number	1	Returns the theater number entered on the configuration page.
lss100.sys.ver	H\t130522\t120530	Returns the circuit board version, the firmware version, and the bootloader versions, separated by tab.
lss100.sys.xy	0.314743\t0.353419	Returns the chromaticity as x tab y.
lss100.sys.capture_spl SPL Center Low 81.2 83.2	83.239520	Instructs the LSS-100P to capture the current SPL to its log. The parameters are description, min, and max. Returns the current SPL in dBc.
lss100.sys.capture_fl Luminance 13 15	14.1234	Instructs the LSS-100P to capture the luminance (measured in fL) to its log. The parameters are description, min, and max.
lss100.sys.capture_cdm2 Luminance 47 49	48.4321	Instructs the LSS-100P to capture the luminance (measured in cd/m ²) to its log. The parameters are description, min, and max.
lss100.sys.capture_cct Color Temperature 6100 6300	6262	Instructs the LSS-100P to capture the correlated color temperature in Kelvin to its log. The parameters are description, min, and max

lss100.sys.capture_temperature_c Temperature 20 40	25	Instructs the LSS-100P to capture its internal temperature in Celcius to its log. The parameters are description, min, and max.
lss100.sys.capture_temperature_f Temperature 60 80	70	Instructs the LSS-100P to capture its internal temperature in Fahrenheit to its log. The parameters are description, min, and max.
lss100.sys.capture_x Color 0.308 0.320	0.314	Instructs the LSS-100P to capture the color coordinate x. The parameters are description, Xmin, Xmax.
lss100.sys.capture_y Color 0.345 0.357	0.351	Instructs the LSS-100P to capture the color coordinate y. The parameters are description, Ymin, Ymax.
lss100.sys.cp850_test_start 192.168.1.146		Sends a command to a Dolby CP850 to output a test signal. The test signal is pink noise that rotates through all speakers.
lss100.sys.cp_850_test_stop		Stops the test signal generation in the Dolby CP850 and returns it to normal operation.
lss100.sys.log_post http://lss.uslinc.com/post.php lss.100.sys.log_post http://user:pw@example.com:1234/path/filename		Posts logs in XML to the specified URL. The URL can be HTTP or HTTPS. The post can use either HTTP or HTTPS. The URL can include a username, password, and port number, if desired. Posts all log data since the last log post to this URL. If more than one post is included in a script, add a wait of 60 seconds between posts to allow time for the first to complete.
lss100.sys.tcp_send_string address port string lss100.sys.tcp_send_string 192.168.1.123 10001 qli32.sys.test.speaker_test 15 1\r		Allows a user to have the LSS-100P relay a TCP string to another device.
lss100.sys.script_run 0		Runs the specified script. If no script number is specified, runs script 0 (the first one).

lss100.sys.script_wait 30		Causes a script to wait the specified number of seconds before executing the next line. Waits between captures keeps the measurement capture synchronized with the test content.
---------------------------	--	--

Figure 18 - LSS-100P TCP Commands

TCP_Send Command Usage

The tcp_send command allows a user to have the LSS relay TCP strings to other devices by having the command embedded within a script. The usage of this command is shown below:

```
lss100.sys.tcp_send_string|address|port|string
```

Example:

```
lss100.sys.tcp_send_string|192.168.1.123|10001|qli32.sys.test.speaker_test 15 1\r
```

The example command tells a Lexicon QLi32 (located at 192.168.1.123, port 10001) to put pink noise on each speaker in sequence for 15 seconds (looping once). An LSS-100P script can capture the SPL of each of the speakers.

Allowed escape codes are:

\\ = backslash

\t = tab

\n = newline

\r = carriage return

\a = alarm (bell)

\f = form feed

\v = vertical tab

\b = backspace

CP850 Control

The LSS-100P is capable of integration with a Dolby® CP850 Cinema Processor to check individual speakers in a Dolby ATMOS® configuration. To unlock access to TCP commands that control the Dolby® CP850 Cinema Processor contact USL for a license key.

The command below causes the LSS-100P to send a command to the CP850 at the specified address (192.168.1.146 in the example) to go into a test mode. In this mode, the CP850 sends pink noise to each speaker individually. By timing how much time is spent on each speaker, a custom test script can be written so the LSS-100P captures the SPL on each speaker.

```
lss100.sys.cp850_test_start|192.168.1.146
```

The command below causes the LSS-100P to send a command to the CP850 stopping the test. The IP address specified in the last cp850_test_start is used.

```
lss100.sys.cp_850_test_stop
```

Log Post XML Format

Sample XML data posted to a web server is shown below. Note that the web server must accept chunked data as defined in RFC 2616 section 3.6.1. Note that DateTime is a Unix time stamp (seconds since January 1, 1970 UTC).

```
<?xml version="1.0" encoding="UTF-8"?>
<LssLogPost>
<Record>
<RecordNum>996</RecordNum>
<DateTime>1440661743</DateTime>
<Description>Posted to http://lss.hallikainen.org/post.php</Description>
<Value>3.39e+03</Value>
<Units></Units>
<Minimum>-9e+09</Minimum>
<Maximum>9e+09</Maximum>
<OutsideLimits>0</OutsideLimits>
<SerialNumber>0157</SerialNumber>
<OrgKey>palm</OrgKey>
<TheaterName>Palm Theatre</TheaterName>
<TheaterNumber>1</TheaterNumber>
<AuditoriumNumber>1</AuditoriumNumber>
<Comments>HW Rev F</Comments>
<Firmware>150721</Firmware>
<Hardware>F</Hardware>
<IpAddress>192.168.1.153</IpAddress>
</Record>
<Record>
<RecordNum>997</RecordNum>
<DateTime>1440661743</DateTime>
<Description>Log post response code</Description>
<Value>200</Value>
<Units></Units>
<Minimum>0</Minimum>
<Maximum>399</Maximum>
<OutsideLimits>0</OutsideLimits>
<SerialNumber>0157</SerialNumber>
<OrgKey>palm</OrgKey>
<TheaterName>Palm Theatre</TheaterName>
<TheaterNumber>1</TheaterNumber>
<AuditoriumNumber>1</AuditoriumNumber>
<Comments>HW Rev F</Comments>
<Firmware>150721</Firmware>
<Hardware>F</Hardware>
<IpAddress>192.168.1.153</IpAddress>
</Record>
<Record>
<RecordNum>998</RecordNum>
<DateTime>1440661834</DateTime>
<Description>SPL Silence</Description>
<Value>56.4</Value>
<Units>dBc</Units>
<Minimum>40</Minimum>
<Maximum>60</Maximum>
<OutsideLimits>0</OutsideLimits>
<SerialNumber>0157</SerialNumber>
<OrgKey>palm</OrgKey>
<TheaterName>Palm Theatre</TheaterName>
<TheaterNumber>1</TheaterNumber>
<AuditoriumNumber>1</AuditoriumNumber>
<Comments>HW Rev F</Comments>
<Firmware>150721</Firmware>
<Hardware>F</Hardware>
<IpAddress>192.168.1.153</IpAddress>
</Record>
... (additional records)
</LssLogPost>
```

The web server can parse the XML to a database for further analysis and reporting. A simple PHP script that appends each new LSS-100P XML report to a file and mails each report is shown below. This is a good starting point to verify that things are working.

```
<?php
$postData=file_get_contents("php://input"); // get post data into a string
file_put_contents("/tmp/PostTest.txt",$postData,FILE_APPEND); // append post data to a
file
// Set up to mail data
$to='name@example.com';
$subject='LSS-100 Post Data';
$headers= 'From: LSS@example.com';
mail($to, $subject, $postData, $headers);
?>
```

LSS-DB

LSS-DB is a free database program designed for use with the LSS-100P. It consists of PHP scripts and javascript to capture XML posts from LSS-100P units and present the data to users. LSS-DB is designed for use by theater chains or theater service companies that operate a Network Operations Center. LSS-DB separates data from LSS-100P units by OrgKey. Users are only allowed access to data with a corresponding OrgKey. A single service company can serve many different theater chains with one LSS-DB installation. An online demo can be viewed at <http://lssdb.uslinc.com> . LSS-DB can be downloaded from <http://ftp.uslinc.com/?dir=ftp/Products/LSS-DB> .

Hidden Screens

The LSS-100P has a few hidden screens that are described below. One shows the configuration data for the unit. The other two allow for calibration (or mis-calibration) of the unit.

View Configuration Data

The LSS-100P configuration is saved as text in a series of commands. These commands are sent through the same command interpreter as commands received over TCP or from a script. You can view this data at <http://xxx.xxx.xxx.xxx/ConfigFlash.html> (substituting the IP address of the LSS-100P for the xxx).

Calibration Screens

These screens are supplied to allow for field calibration of the LSS-100P. You should ONLY attempt this if you have accurate reference instrumentation. Light calibration is to be done with a projector having the same illumination source as will be used in operation. If a xenon projector is to be used, the LSS-100P must be calibrated with a xenon source (ideally the same projector). Luminance and color MUST be measured with a spectrometer-based instrument, such as the USL PCA-100. Reference measurements should be made as close to the LSS-100P position as possible. Do not attempt calibration without the appropriate equipment.

Two calibration screens are available:

- <http://xxx.xxx.xx.xx/protect/cal.html> - Calibration using cd/m².
- <http://xxx.xxx.xx.xx/protect/calf.html> - Calibration using fL.

These screens are similar. A portion of the cal.html screen is shown in Figure 19.

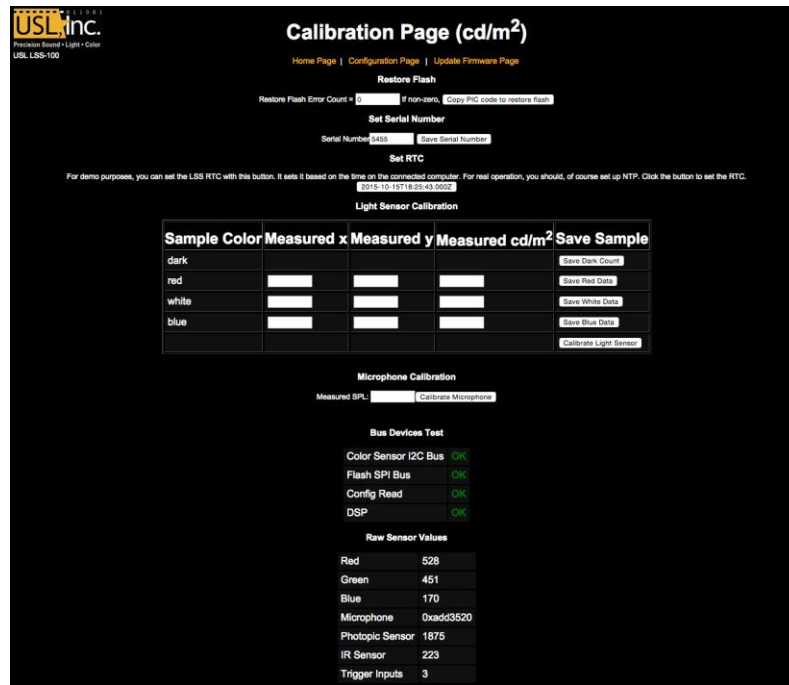

Figure 19 - LSS-100P Calibration Screen

Besides calibration, these screens includes factory configuration features and debug information. The Copy PIC code to restore flash copies the currently loaded firmware to external flash as a backup. The number to the left of this button is a count of how many bytes disagree. We recommend not clicking this button in the field. Keeping the factory firmware as a backup allows you to go back to it should something go wrong.

The Set Serial Number button is not normally used in the field. The MAC address of the LSS-100P is based on the serial number.

Use the procedure below to calibrate the light and IR portion of the LSS-100P:

1. Present the LSS-100P with total darkness. This can be accomplished by putting a lens cap over the lens or by dowsing the projector and removing power from any IR panels in the auditorium. Once the LSS-100P is presented with total darkness, click the "Save Dark Count" button. This sets a dark reference for both the luminance and IR sensors.
2. Project a full-screen red test pattern on the screen. Measure the color (x,y) and luminance with the spectrometer-based reference meter. While the test pattern is still on the screen, key these values in the "red" line of the calibration form, then click "Save Red Data."
3. Project a full-screen white test pattern on the screen. Measure the color (x,y) and luminance with the spectrometer-based reference meter. While the test pattern is still on the screen, key these values in the "white" line of the calibration form, then click "Save White Data."
4. Project a full-screen blue test pattern on the screen. Measure the color (x,y) and luminance with the spectrometer-based reference meter. While the test pattern is still on the screen, key these values in the "blue" line of the calibration form, then click "Save Blue Data."
5. Click the "Calibrate Light Sensor" button.

To calibrate the SPL meter, place a sound level calibrator, such as the Reed SC-05 over the LSS-100P microphone. Set the sound calibrator to 94dB. Key 94 into the Measured SPL field, then click the Calibrate Microphone button.

The remainder of the screen includes information to aid in the production test of the LSS-100P. It can be ignored while doing field calibration of the LSS-100P.

Firmware Update

USL may offer firmware updates to add features to the LSS-100P. Firmware updates are delivered as a “hex” file. To install the update, click on “Update Firmware Page” on the “Configuration Page.” The firmware update page is shown in Figure 20. Note that some firmware updates may result in a change in log format. For this reason, this page includes a “Clear Log” button. This button can also be used to clear the log for other reasons.

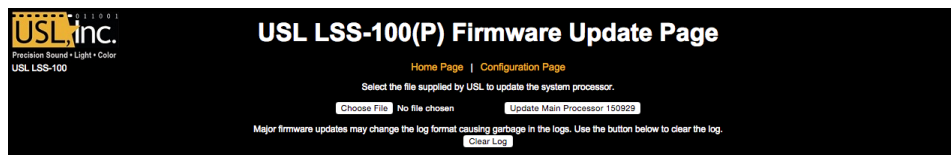

Figure 20 - LSS-100P firmware update page.

Follow these step-by-step instructions to do a firmware update:

1. Use the browse button to select the hex file to be loaded into the LSS-100P.
2. Press “Update Main Processor.” The green LED on the LSS-100P will flash as the new firmware is installed. After the new code is uploaded to the LSS-100P, the browser will return a “Connection Reset” message. This happens when the LSS-100P reboots with the new firmware.

If a firmware update is interrupted, it is possible for the LSS-100P to cease operating. To restore the factory firmware (allowing another attempt at the update), hold down the restore button as power is applied to the LSS-100P. If the button is held for about 1 second before and 1 second after power is applied, the factory firmware will be reloaded and system configuration will remain unchanged. The green LED flashes as the firmware is reloaded. Once the system is up and running, pressing the restore button will restore the default IP address (169.254.1.6).

Restore Button

The restore button on the LSS-100P serves two purposes:

1. If the restore button is momentarily pressed while the LSS-100P is operating, the IP address is temporarily changed to its default IP address (169.254.1.6). It will stay at this IP address until the next power cycle.
2. If the restore button is held down 1 second before applying power until 1 second after applying power, the factory firmware is reloaded. This can be used if a firmware update fails and leaves the system inoperable. The green LED will flash as the firmware is reloaded. No configuration is changed in this process. The unit will remain at the same IP address.

Useful Software

Several programs are available on the USL website that should prove useful with the LSS-100P.

URL	Description
http://ftp.uslinc.com/?dir=ftp/Products/EthernetDeviceDiscoverer	Ethernet Discoverer - Finds USL products on the network. Shows the MAC address, IP address, host name and other information. Clicking on a listing opens the home web page of the device. Also reports logged out of tolerance information from the LSS-100P. Windows and iOS versions are available
http://ftp.uslinc.com/MultiProduct/Realterm_2.0.0.57_setup.zip	Real Term – A terminal program that can be used to send commands and see responses over RS232 or TCP.
http://ftp.uslinc.com/MultiProduct/ttermpro23.zip	Tera Term Pro – A terminal program that can be used to type commands to the LSS-100P and see responses.
http://ftp.uslinc.com/?dir=ftp/Products/LSS-100P/Software/TestContent	LST-100 Test DCP – Use this digital cinema content for the DCP-based operation of the LSS-100P. This DCP is also available on a flash drive from USL. Order part number LST-100.
http://ftp.uslinc.com/?dir=ftp/Products/LSS-DB	LSS-DB. A PHP/javascript application that reports on thousands of LSS-100P units.

Ethernet Device Discoverer

The USL Ethernet Device Discoverer is a helpful tool used to locate multiple LSS-100P's and other USL products on a network. For LSS-100P's it also shows summaries and warning messages if any readings fall out of tolerance within a set number of days. The amount of days to look for out of tolerance conditions can be set on the main Configuration Page of each individual LSS-100P. Since it is able to display multiple devices on a single page it may be the easiest way to get an overview of an entire multiplex of LSS-100P's.

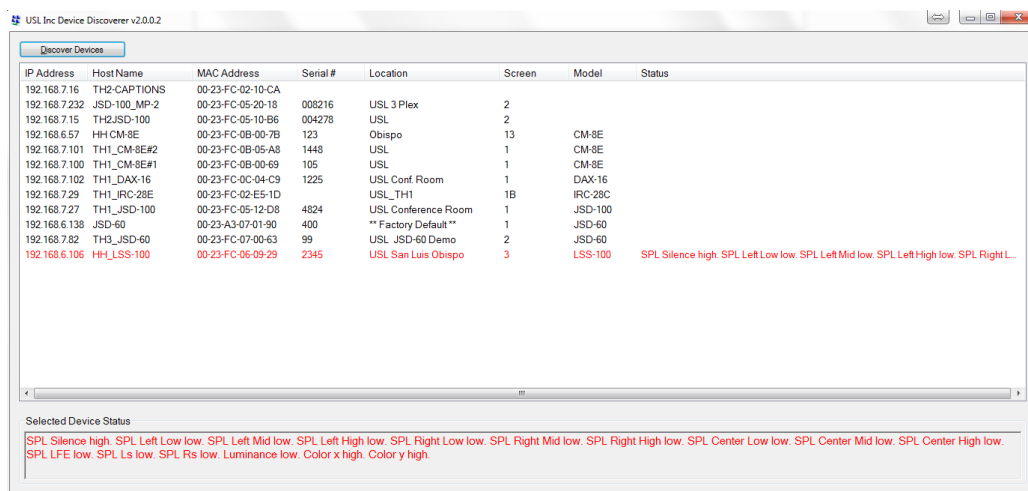

IP Address	Host Name	MAC Address	Serial #	Location	Screen	Model	Status
192.168.7.16	TH2-CAPTIONS	00-23-FC-02-10-CA					
192.168.7.232	JSD-100_MP-2	00-23-FC-05-20-18	008216	USL 3 Plex	2		
192.168.7.15	TH2JSD-100	00-23-FC-05-10-B6	004278	USL	2		
192.168.6.57	HH1 CM-8E	00-23-FC-08-00-7B	123	Obispo	13	CM-8E	
192.168.7.101	TH1_CM-8E#2	00-23-FC-08-05-A8	1448	USL	1	CM-8E	
192.168.7.100	TH1_CM-8E#1	00-23-FC-08-00-69	105	USL	1	CM-8E	
192.168.7.102	TH1_DAX-16	00-23-FC-0C-04-C9	1225	USL Conf. Room	1	DAX-16	
192.168.7.29	TH1_IRC-28E	00-23-FC-02-E5-1D		USL_TH1	1B	IRC-28C	
192.168.7.27	TH1_JSD-100	00-23-FC-05-12-58	4824	USL Conference Room	1	JSD-100	
192.168.6.138	JSD-60	00-23-A3-07-01-90	400	** Factory Default **	1	JSD-60	
192.168.7.82	TH3_JSD-60	00-23-FC-07-00-E3	99	USL JSD-60 Demo	2	JSD-60	
192.168.6.105	HH1_LSS-100	00-23-FC-06-09-29	2345	USL San Luis Obispo	3	LSS-100	SPL Silence high, SPL Left Low low, SPL Left Mid low, SPL Left High low, SPL Right L...

Selected Device Status

SPL Silence high, SPL Left Low low, SPL Left Mid low, SPL Left High low, SPL Right Low low, SPL Right Mid low, SPL Right High low, SPL Center Low low, SPL Center Mid low, SPL Center High low, SPL LFE low, SPL Ls low, SPL Rs low, Luminance low, Color x high, Color y high.

Figure 21 – Ethernet Device Discoverer Overview

LSS Database Software

The LSS Database (LSS-DB) is designed to provide a collection point for LSS-100P data transmitters and an observation platform for reviewing the results of the collected data.

Remote LSS-100P devices that have been installed in theaters will post the results of each test to a URL (Uniform Resource Locator) where the LSS-DB collects the data. The LSS Database provides a mechanism to collect the LSS-100P data and store it in a database. This operation is performed automatically and requires no intervention by the end user.

Visit the following URL for download and more info: <http://ftp.uslinc.com/?dir=ftp/Products/LSS-DB>

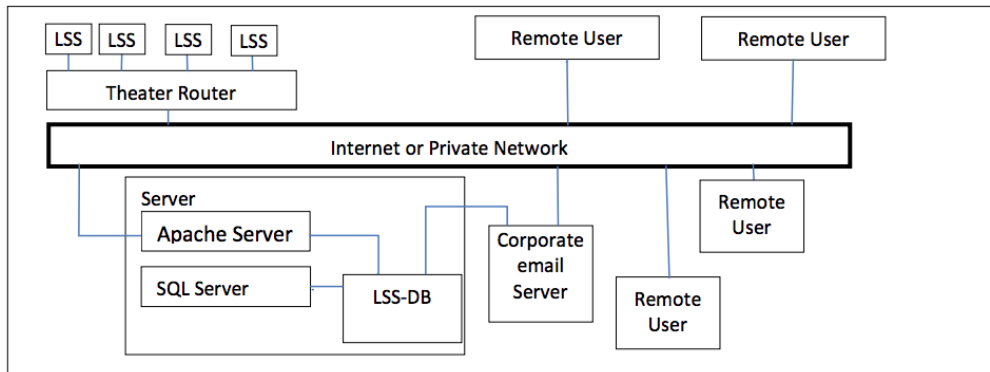

Figure 22 – LSS Database Overview

Appendix A – Red/Green Flash Script Start

LSS-100P installation is simplified by using a red and green flash sequence to start script execution. The flash sequence avoids the need to add a cue (send TCP string or provide contact closure) to start a script. The LSS-100P compares the output of the red and green sensors. When the green to red ratio exceeds a threshold, the image is considered a binary 1. When the red to green ratio exceeds a threshold, the image is considered a binary 0. A single ASCII character is sent using a sequence of red and green images. The character is sent at 0.5 bits per second (2 seconds per bit). The character consists of a start bit (0), 8 data bits with the least significant bit sent first, then one stop bits (1). The most significant bit is 0. The script starts on the 0 to 1 transition between the most significant bit and the stop bit. Because of this, the script starts two seconds (one bit time) before the end of the clip. This two second difference needs to be taken into consideration when writing scripts. Bits are sampled in the middle of the bit time (based on the 1 to 0 transition of the beginning of the start bit). The letter 'A' starts script 0 (the first one).

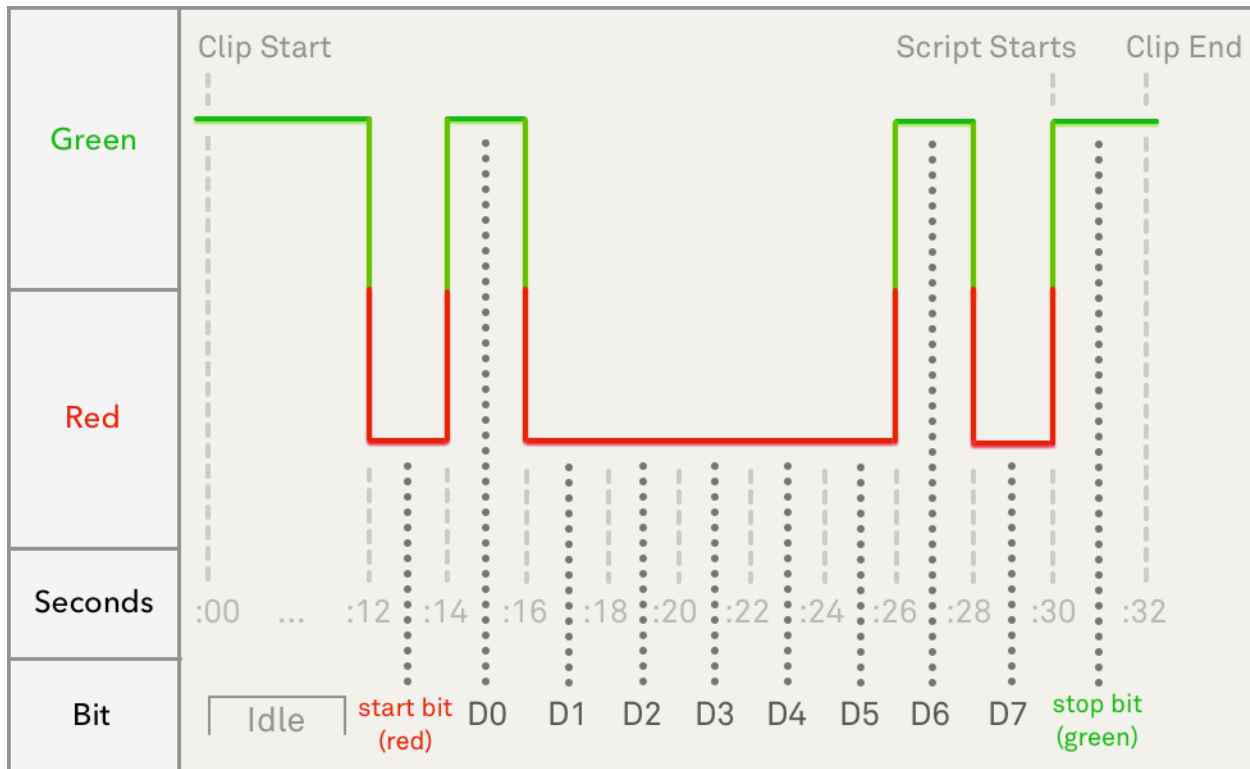

Figure 23 - Red/Green flash timing diagram. This sequence represents the letter A (0x41) and will start script 0.

Appendix B – USB Power Interface and Contact Closure Script Start

Besides Power Over Ethernet, the LSS-100P can also be powered by a 5VDC power supply driving a mini-USB connector. A standard USB to min-USB cable can be used. As an alternative, USL can supply 10m (30 ft) long cable, adapter board, and USB power supply to drive the LSS-100P. These can be used to power the LSS-100P and use contact closures to start scripts.

Terminal	Wire Color	Wire Color
+5V	Red	Red
A	Blue	White
B	Yellow	Green
C	none	none
Ground	Black	Black

Figure 24 - USB Adapter Pin-Out

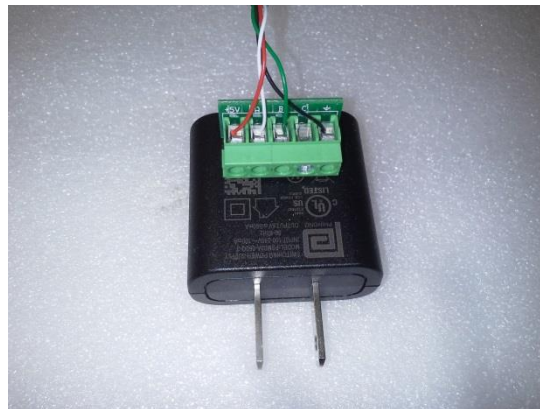

Figure 25 - USB Adapter Wiring

Note orientation of adapter in USB power supply (terminals down).

1. If USB power or contact closure script triggering is being used, connect the supplied cable to the LSS-100P. Connect the other end of the cable to the USB adapter board. Refer to Figures 23 and 24 for wiring instructions. If contact closure script triggering is being used with Power Over Ethernet, the USB cable can be routed directly to the GPIO connections on the server. Refer to figure 4 for wire colors.
2. If contact closure script triggering is to be used, connect the contact closures from the digital cinema server to the USB adapter board as shown in Figure 25. Pulses should be about 500ms long.

Pulse to ground	To Start Script
A	0
B	1
C	2

Figure 26 - LSS-100P USB Adapter to Cinema Server GPIO Wiring

- a) Define a cue at the start of the Show Playlist to pulse (500ms) a contact closure between terminals A and ground on the USB adapter board. This contact closure or the Ethernet command causes the LSS-100P to start executing script 0 (the first script).

Appendix C – Language Support

The primary language of the LSS-100P is English. User defined fields on the home page and in scripts may be in any language. The configuration fields accept UTF-8 coding, allowing text of almost any language to be directly keyed in or pasted in.

Certain phrases and words are “hard coded” into the LSS-100P in English. The web interface replaces these phrases and words using javascript when the browser renders the web page. The replacement is based on a table located in the /translate directory. For example, /translate/zh.txt hold the translation table for Chinese. Additional translation tables will be added in the future. The LSS-100P sends the appropriate translation table based on the first language in the Accept-Language HTTP header.

Product Support

USL proudly stands behind its products. We are ready to answer questions about the installation or operation of the LSS-100P. The manual, application notes and other documents are available on our website. You may contact USL by:

Phone: +1 (805) 549-0161

Email: support@uslinc.com

File a support ticket electronically at: www.uslinc.com/support

Please check the USL website for the latest software packages and updates for the LSS-100P product. www.uslinc.com

USL is interested in your comments. Please feel free to contact us with any comments or suggestions.

Warranty

USL, INC. warrants that each product manufactured by it will be free from defects in material and workmanship under normal usage over a period of one (1) year after its purchase new from and authorized dealer. Our obligation under this warranty is limited to repairing or replacing any product or component which we are satisfied does not conform with the foregoing warrantee and which is returned to our factory freight paid, or serviced by one of our authorized contractors. The foregoing warranty is exclusive and in lieu of all other warranties, whether expressed or implied. Such warranty shall not apply to any product or component (A) repaired or altered by anyone other than USL, Inc. or an authorized service contractor; (B) tampered with or altered in any way or subjected to misuse, negligence or accident or (C) which has been improperly connected, installed or adjusted other than in accordance with USL, Inc.'s instruction.

Manual Revision History

Rev.	Description	Date
1	Original manual.	111107
2	Revisions for firmware and hardware changes.	120112
3	Revisions to accommodate hardware and firmware update.	120217
4	Editorial revisions	120501
5	Add documentation on DCP-based operation of the LSS-100P.	130614
6	Add documentation on new hardware, scripting, etc.	140604
A	Added ToC, Support section, improved formatting.	140619
B	Added documentation for new features.	151015
C	Added documentation for new features.	160318